



geboplast

VÝROBNÝ PROGRAM

Plastové svorné spojky a plastové navrtávky:

Geboplast svorné spojky z umelej hmoty a navrtávky sú rozmeroch od 16 mm do 110 mm v nasledujúcom prevedení:



SPOJENIA

S. 94-95

Spojka priama s vnútorným alebo vonkajším závitom.



SPOJKY

S. 96-97

Priama spojka a redukcia.



T-KUSY

S. 98-101

T-kus, tri strany pre uchytenie alebo tri strany pre uchytenie s redukovaným výstupom, ako aj T-kus s vnútorným závitom alebo T-kus s vonkajším závitom.



KOLENÁ 90°

S. 102-106

Koleno 90°, obe strany pre uchytenie, alebo ako koleno s vonkajším alebo vnútorným závitom.



RÔZNE ŠPECIÁLNE RIEŠENIA

S. 107

Ako prírubový hrdlový kus s voľnou prírubou. Ako spojka s upevnením na stenu a s vnútorným závitom. Ako zátka.



NÁHRADNÉ DIELY PRE PLASTOVÉ SPOJKY

S. 108



SEDLÁ

S. 111-112

Navrtávka je vhodná pre následné odbočky vodovodného rozvodu z PE rúr



DODATOČNÉ MONTÁŽNE ZARIADENIA K PLASTOVÝM SPOJKÁM

S. 113

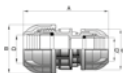

POKYNY PRE MONTÁŽ

S. 109, 113

DŮLEŽITÉ POZNATKY

Skúšky:

Plastová spojka sa skúša podľa DVGW-Reg. Číslo. DW-8616BT0102 pre PE rúry podľa DIN 8074 príp. DIN EN 12201.

Všetky komponenty, ktoré sú v kontakte s pitnou vodou, zodpovedajú súčasným hygienickým požiadavkám.

Závitové a prírubové pripojenia:

- Voľna príruha podľa DIN EN 1092-1
- Pripojovací závit podľa ISO 7/1 príp. DIN EN 10226-1

Materiály:

- **Teleso:** Kopolymer (PP-B), odolný oproti UV žiareniu
- **Prítlačné tesnenie:** Polypropylén
- **Kuželová matice:** Polypropylén, odolný oproti UV žiareniu
- **Svorný krúžok:** Polyacetal Resin (POM)
- **O-krúžok:** NBR/EPDM certifikované pre pitnú vodu
- **Zosilňovací krúžok:** Ušľachtilá oceľ, AISI 430, pre vnútorný závit 1 1/4" – 4"

Médium: Pitná voda

Pretlakový stupeň:

Pri teplote do 25 °C, dávame plastovú spojku plastovou svorku 16 – 63 mm pre PN 16 a 75 – 110 mm pre PN 10.

Zmena pretlakového stupňa v závislosti od teploty, pozri graf nižšie.

Pretlakové stupne v závislosti od teploty:

Teplota v °C	0 až 25	26 až 35	36 až 45
16 – 63	16	12.5	10
75 – 110	10	8	6

SPOJKA PRIAMA, S VNÚTORNÝM ZÁVITOM 1 1/4 S UŠLACHTILÍM OCEĽOVÝM ZOSILŇOVACÍM KRÚŽKOM

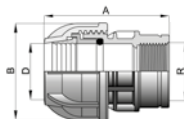

DN	Vonkajší priemer rúry-Ø [mm] x závit	Výrobok č.
10	16 x 1/2"	13011601
10	16 x 3/4"	13011602
15	20 x 1/2"	13012001
15	20 x 3/4"	13012002
20	25 x 1/2"	13012501
20	25 x 3/4"	13012502
20	25 x 1"	13012503
25	32 x 1/2"	13013201
25	32 x 3/4"	13013202
25	32 x 1"	13013203
25	32 x 1 1/4"	13013204
32	40 x 1"	13014003
32	40 x 1 1/4"	13014004
32	40 x 1 1/2"	13014005
40	50 x 1 1/4"	13015004
40	50 x 1 1/2"	13015005
40	50 x 2"	13015006
50	63 x 1 1/4"	13016304
50	63 x 1 1/2"	13016305
50	63 x 2"	13016306
65	75 x 2"	13017506
65	75 x 2 1/2"	13017507
80	90 x 2 1/2"	13019007
80	90 x 3"	13019008
100	110 x 3"	130111008
100	110 x 4"	130111009

ROZMERY A HMOTNOSTI

DN	Vonkajší priemer rúry-Ø [mm]	Závit R ISO 7/1	Výrobok č.	A [mm]	B [mm]	D [mm]	Hmotnosť [kg]
10	16	1/2"	13011601	59	39	17	0.022
10	16	3/4"	13011602	60	39	17	0.022
15	20	1/2"	13012001	67	46	21	0.032
15	20	3/4"	13012002	68	46	21	0.034
20	25	1/2"	13012501	73	55	26	0.055
20	25	3/4"	13012502	76	55	26	0.058
20	25	1"	13012503	78	55	26	0.059
25	32	1/2"	13013201	83	64	33	0.081
25	32	3/4"	13013202	84	64	33	0.083
25	32	1"	13013203	86	64	33	0.086
25	32	1 1/4"	13013204	89	64	33	0.111
32	40	1"	13014003	101	74	42	0.132
32	40	1 1/4"	13014004	102	74	42	0.149
32	40	1 1/2"	13014005	100	74	42	0.160
40	50	1 1/4"	13015004	122	87	51	0.227
40	50	1 1/2"	13015005	120	87	51	0.226
40	50	2"	13015006	125	87	51	0.232
50	63	1 1/4"	13016304	134	107	65	0.340
50	63	1 1/2"	13016305	139	107	65	0.383
50	63	2"	13016306	138	107	65	0.389
65	75	2"	13017506	181	131	78	0.630
65	75	2 1/2"	13017507	187	131	78	0.646
80	90	2 1/2"	13019007	209	154	92	0.947
80	90	3"	13019008	216	154	92	1.013
100	110	3"	130111008	245	185	112	1.650
100	110	4"	130111009	251	185	112	1.650

SPOJKA PRIAMA, S VONKAJŠÍM ZÁVITOM

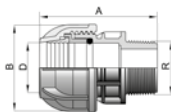

DN	Vonkajší priemer rúry- \emptyset [mm] x závit	Výrobok č.
10	16 x 1/2"	13001601
10	16 x 3/4"	13001602
15	20 x 1/2"	13002001
15	20 x 3/4"	13002002
20	25 x 1/2"	13002501
20	25 x 3/4"	13002502
20	25 x 1"	13002503
25	32 x 3/4"	13003202
25	32 x 1"	13003203
25	32 x 1 1/4"	13003204
32	40 x 1"	13004003
32	40 x 1 1/4"	13004004
32	40 x 1 1/2"	13004005
40	50 x 1 1/4"	13005004

DN	Vonkajší priemer rúry- \emptyset [mm] x závit	Výrobok č.
40	50 x 1 1/2"	13005005
40	50 x 2"	13005006
50	63 x 1 1/2"	13006305
50	63 x 2"	13006306
50	63 x 2 1/2"	13006307
65	75 x 2"	13007506
65	75 x 2 1/2"	13007507
65	75 x 3"	13007508
80	90 x 2"	13009006
80	90 x 2 1/2"	13009007
80	90 x 3"	13009008
80	90 x 4"	13009009
100	110 x 3"	130011008
100	110 x 4"	130011009

ROZMERY A HMOTNOSTI

DN	Vonkajší priemer rúry- \emptyset [mm]	Závit R ISO 7/1	Výrobok č.	A [mm]	B [mm]	D [mm]	Hmotnosť [kg]
10	16	1/2"	13001601	57	39	17	0.017
10	16	3/4"	13001602	58	39	17	0.019
15	20	1/2"	13002001	64	46	21	0.029
15	20	3/4"	13002002	67	46	21	0.029
20	25	1/2"	13002501	72	55	26	0.052
20	25	3/4"	13002502	73	55	26	0.052
20	25	1"	13002503	76	55	26	0.055
25	32	3/4"	13003202	81	64	33	0.079
25	32	1"	13003203	84	64	33	0.081
25	32	1 1/4"	13003204	85	64	33	0.085
32	40	1"	13004003	100	74	42	0.121
32	40	1 1/4"	13004004	101	74	42	0.131
32	40	1 1/2"	13004005	98	74	42	0.153
40	50	1 1/4"	13005004	121	87	51	0.210
40	50	1 1/2"	13005005	120	87	51	0.210
40	50	2"	13005006	125	87	51	0.220
50	63	1 1/2"	13006305	137	107	65	0.348
50	63	2"	13006306	137	107	65	0.362
50	63	2 1/2"	13006307	144	107	65	0.364
65	75	2"	13007506	180	131	78	0.575
65	75	2 1/2"	13007507	186	131	78	0.598
65	75	3"	13007508	189	131	78	0.615
80	90	2"	13009006	205	154	92	1.018
80	90	2 1/2"	13009007	212	154	92	0.908
80	90	3"	13009008	214	154	92	0.925
80	90	4"	13009009	221	154	92	0.989
100	110	3"	130011008	246	185	112	1.569
100	110	4"	130011009	254	185	112	1.603

SPOJKA PRIAMA, OBOJSTRANNÉ UCHYTENIE



DN	Vonkajší priemer rúry- θ [mm] x závit	Výrobok č.
10	16 x 16	130216
15	20 x 20	130220
20	25 x 25	130225
25	32 x 32	130232
32	40 x 40	130240
40	50 x 50	130250
50	63 x 63	130263
65	75 x 75	130275
80	90 x 90	130290
100	110 x 110	1302110

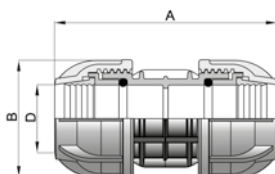

ROZMERY A HMOTNOSTI

DN	Vonkajší priemer rúry- θ [mm]	Výrobok č.	A [mm]	B [mm]	D [mm]	Hmotnosť [kg]
10	16	130216	77	39	17	0.029
15	20	130220	92	46	21	0.050
20	25	130225	108	55	26	0.092
25	32	130232	124	64	33	0.142
32	40	130240	151	74	42	0.228
40	50	130250	189	87	51	0.371
50	63	130263	218	107	65	0.641
65	75	130275	281	131	78	1.025
80	90	130290	330	154	92	1.614
100	110	1302110	390	185	112	2.796

SPOJKA PRIAMA, REDUKOVANÁ



DN	Vonkajší priemer rúry- θ [mm] x závit	Výrobok č.
15 x 10	20 x 16	13062016
20 x 15	25 x 20	13062520
25 x 20	32 x 25	13063225
32 x 20	40 x 25	13064025
32 x 25	40 x 32	13064032
40 x 20	50 x 25	13065025
40 x 25	50 x 32	13065032
40 x 32	50 x 40	13065040
50 x 32	63 x 40	13066340
50 x 40	63 x 50	13066350
65 x 40	75 x 50	13067550
65 x 50	75 x 63	13067563
80 x 50	90 x 63	13069063
80 x 65	90 x 75	13069075
100 x 80	110 x 90	130611090

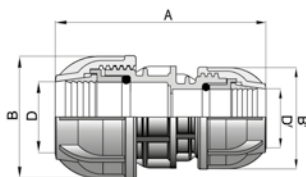

ROZMERY A HMOTNOSTI

DN	Vonkajší priemer rúry- θ [mm]	Výrobok č.	A [mm]	B [mm]	D [mm]	B' [mm]	D' [mm]	Hmotnosť [kg]
15 x 10	20 x 16	13062016	84	46	21	39	17	0.037
20 x 15	25 x 20	13062520	99	55	26	46	21	0.073
25 x 20	32 x 25	13063225	115	64	33	55	26	0.119
32 x 20	40 x 25	13064025	134	74	42	55	26	0.157
32 x 25	40 x 32	13064032	138	74	42	64	33	0.186
40 x 20	50 x 25	13065025	152	87	51	55	26	0.245
40 x 25	50 x 32	13065032	150	87	51	64	33	0.249
40 x 32	50 x 40	13065040	165	87	51	74	42	0.289
50 x 32	63 x 40	13066340	174	107	65	74	42	0.432
50 x 40	63 x 50	13066350	195	107	65	87	51	0.500
65 x 40	75 x 50	13067550	245	131	78	87	51	0.740
65 x 50	75 x 63	13067563	257	131	78	107	65	0.859
80 x 50	90 x 63	13069063	280	154	92	107	65	1.176
80 x 65	90 x 75	13069075	315	154	92	131	78	1.362
100 x 80	110 x 90	130611090	370	185	112	154	92	2.285

T-KUS, S TROJSTRANNÝM UCHYTENÍM



DN	Vonkajší priemer rúry-Ø [mm] x zavít x Vonkajší priemer rúry-Ø [mm]	Výrobok č.
10	16 x 16 x 16	131016
15	20 x 20 x 20	131020
20	25 x 25 x 25	131025
25	32 x 32 x 32	131032
32	40 x 40 x 40	131040
40	50 x 50 x 50	131050
50	63 x 63 x 63	131063
65	75 x 75 x 75	131075
80	90 x 90 x 90	131090
100	110 x 110 x 110	1310110

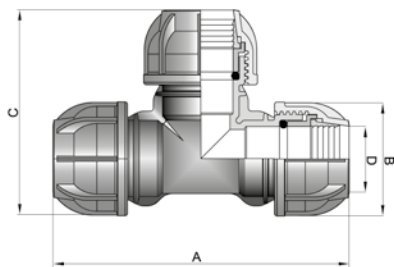

ROZMERY A HMOTNOSTI

DN	Vonkajší priemer rúry-Ø [mm]	Výrobok č.	A [mm]	B [mm]	D [mm]	C [mm]	Hmotnosť [kg]
10	16	131016	96	39	17	67	0.044
15	20	131020	121	46	21	84	0.071
20	25	131025	145	55	26	100	0.151
25	32	131032	170	64	33	116	0.238
32	40	131040	195	74	42	135	0.371
40	50	131050	245	87	51	175	0.617
50	63	131063	290	107	65	203	1.070
65	75	131075	365	131	78	250	1.674
80	90	131090	415	154	92	285	2.638
100	110	1310110	535	185	112	350	4.610

T-KUS, S TROMI STRANAMI K UCHYTENIU, S REDUKOVANÝM VÝSTUPOM



DN	Vonkajší priemer rúry-Ø [mm] x zavit x Vonkajší priemer rúry-Ø [mm]	Výrobok č.
20 x 15	25 x 20 x 25	13122520
25 x 20	32 x 25 x 32	13123225
32 x 25	40 x 32 x 40	13124032
40 x 32	50 x 40 x 50	13125040
50 x 40	63 x 50 x 63	13126350

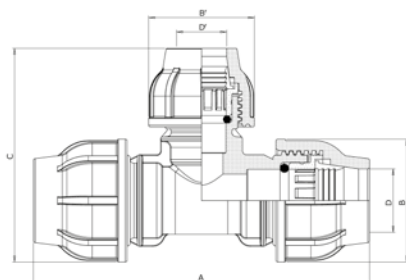

ROZMERY A HMOTNOSTI

DN	Vonkajší priemer rúry-Ø [mm]	Výrobok č.	A [mm]	B [mm]	D [mm]	C [mm]	B' [mm]	D' [mm]	Hmotnosť [kg]
20 x 15	25 x 20	13122520	145	55	26	91	46	21	0.104
25 x 20	32 x 25	13123225	170	64	33	110	55	26	0.203
32 x 25	40 x 32	13124032	195	74	42	129	64	33	0.330
40 x 32	50 x 40	13125040	245	87	51	152	74	42	0.522
50 x 40	63 x 50	13126350	294	107	65	182	87	51	0.935

T-KUS S VONKAJŠÍM ZÁVITOM

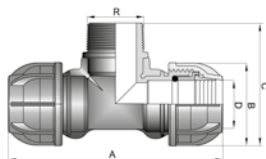

DN	Vonkajší priemer rúry-0 [mm] x závit x Vonkajší priemer rúry-0 [mm]	Výrobok č.
10	16 x 1/2" x 16	13111601
10	16 x 3/4" x 16	13111602
15	20 x 1/2" x 20	13112001
15	20 x 3/4" x 20	13112002
20	25 x 1/2" x 25	13112501
20	25 x 3/4" x 25	13112502
20	25 x 1" x 25	13112503
25	32 x 3/4" x 32	13113202
25	32 x 1" x 32	13113203
32	40 x 1 1/4" x 40	13114004
32	40 x 1 1/2" x 40	13114005
40	50 x 1 1/2" x 50	13115005
40	50 x 2" x 50	13115006
50	63 x 2" x 63	13116306
65	75 x 2 1/2" x 75	13117507
65	75 x 3" x 75	13117508
80	90 x 3" x 90	13119008
80	90 x 4" x 90	13119009
100	110 x 4" x 110	131111009

ROZMERY A HMOTNOSTI

DN	Vonkajší priemer rúry-Ø [mm]	Závit R ISO 7/1	Výrobok č.	A [mm]	B [mm]	D [mm]	C [mm]	Hmotnosť [kg]
10	16	1/2"	13111601	97	39	17	54	0.035
10	16	3/4"	13111602	121	39	17	64	0.035
15	20	1/2"	13112001	120	46	21	64	0.057
15	20	3/4"	13112002	120	46	21	64	0.062
20	25	1/2"	13112501	145	55	26	72	0.107
20	25	3/4"	13112502	144	55	26	71	0.109
20	25	1"	13112503	144	55	26	76	0.116
25	32	3/4"	13113202	169	64	33	82	0.166
25	32	1"	13113203	170	64	33	86	0.170
32	40	1 1/4"	13114004	195	74	42	103	0.286
32	40	1 1/2"	13114005	194	74	42	103	0.294
40	50	1 1/2"	13115005	246	87	51	119	0.457
40	50	2"	13115006	246	87	51	125	0.481
50	63	2"	13116306	290	107	65	143	0.836
65	75	2 1/2"	13117507	365	131	78	174	1.282
65	75	3"	13117508	365	131	78	180	1.333
80	90	3"	13119008	415	154	92	200	2.004
80	90	4"	13119009	415	154	92	210	2.098
100	110	4"	131111009	515	185	112	255	3.600

T-KUS S VNÚTORNÝM ZÁVITOM

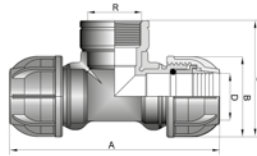

DN	Vonkajší priemer rúry-Ø [mm] x závit x Vonkajší priemer rúry-Ø [mm]	Výrobok č.
10	16 x 1/2" x 16	13041601
10	16 x 3/4" x 16	13041602
15	20 x 1/2" x 20	13042001
15	20 x 3/4" x 20	13042002
20	25 x 1/2" x 25	13042501
20	25 x 3/4" x 25	13042502
20	25 x 1" x 25	13042503
25	32 x 1/2" x 32	13043201
25	32 x 3/4" x 32	13043202
25	32 x 1" x 32	13043203
32	40 x 1" x 40	13044003
32	40 x 1 1/4" x 40	13044004
32	40 x 1 1/2" x 40	13044005
40	50 x 1 1/4" x 50	13045004
40	50 x 1 1/2" x 50	13045005
40	50 x 2" x 50	13045006
50	63 x 1 1/2" x 63	13046305
50	63 x 2" x 63	13046306
65	75 x 2" x 75	13047506
65	75 x 2 1/2" x 75	13047507
65	75 x 3" x 75	13047508
80	90 x 2 1/2" x 90	13049007
80	90 x 3" x 90	13049008
80	90 x 4" x 90	13049009
100	110 x 4" x 110	130411009

ROZMERY A HMOTNOSTI

DN	Vonkajší priemer rúry-Ø [mm]	Závit R ISO 7/1	Výrobok č.	A [mm]	B [mm]	D [mm]	C [mm]	Hmotnosť [kg]
10	16	1/2"	13041601	96	39	17	54	0.035
10	16	3/4"	13041602	122	39	17	68	0.042
15	20	1/2"	13042001	120	46	21	64	0.060
15	20	3/4"	13042002	120	46	21	68	0.067
20	25	1/2"	13042501	144	55	26	82	0.107
20	25	3/4"	13042502	146	55	26	76	0.113
20	25	1"	13042503	145	55	26	77	0.122
25	32	1/2"	13043201	170	64	33	78	0.170
25	32	3/4"	13043202	170	64	33	84	0.175
25	32	1"	13043203	171	64	33	91	0.182
32	40	1"	13044003	195	74	42	103	0.291
32	40	1 1/4"	13044004	195	74	42	104	0.304
32	40	1 1/2"	13044005	195	74	42	105	0.331
40	50	1 1/4"	13045004	249	87	51	118	0.480
40	50	1 1/2"	13045005	249	87	51	118	0.505
40	50	2"	13045006	244	87	51	122	0.505
50	63	1 1/2"	13046305	290	107	65	135	0.855
50	63	2"	13046306	290	107	65	141	0.852
65	75	2"	13047506	370	131	78	168	1.359
65	75	2 1/2"	13047507	370	131	78	174	1.304
65	75	3"	13047508	365	131	78	176	1.376
80	90	2 1/2"	13049007	425	154	92	198	2.085
80	90	3"	13049008	425	154	92	198	2.135
80	90	4"	13049009	420	154	92	203	2.176
100	110	4"	130411009	515	185	112	245	3.643

KOLENO 90° PRE OBOJSTRANNÉ UCHYTENIE



DN	Vonkajší priemer rúry- \emptyset [mm] x závit	Výrobok č.
10	16 x 16	130816
15	20 x 20	130820
20	25 x 25	130825
25	32 x 32	130832
32	40 x 40	130840
40	50 x 50	130850
50	63 x 63	130863
65	75 x 75	130875
80	90 x 90	130890
100	110 x 110	1308110

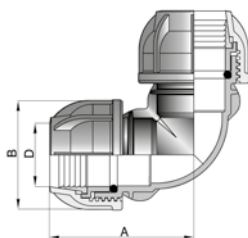

ROZMERY A HMOTNOSTI

DN	Vonkajší priemer rúry- \emptyset [mm]	Výrobok č.	A [mm]	B [mm]	D [mm]	Hmotnosť [kg]
10	16	130816	48	39	17	0.030
15	20	130820	59	46	21	0.047
20	25	130825	72	55	26	0.099
25	32	130832	84	64	33	0.158
32	40	130840	95	74	42	0.246
40	50	130850	122	87	51	0.422
50	63	130863	142	107	65	0.729
65	75	130875	177	131	78	1.138
80	90	130890	212	154	92	1.801
100	110	1308110	260	185	112	3.158

KOLENO 90° S VONKAJŠÍM ZÁVITOM

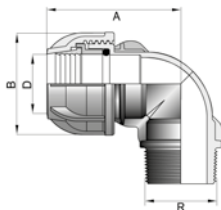

DN	Vonkajší priemer rúry- \varnothing [mm] x závit	Výrobok č.
10	16 x 1/2"	13091601
10	16 x 3/4"	13091602
15	20 x 1/2"	13092001
15	20 x 3/4"	13092002
20	25 x 1/2"	13092501
20	25 x 3/4"	13092502
20	25 x 1"	13092503
25	32 x 3/4"	13093202
25	32 x 1"	13093203
32	40 x 1"	13094003
32	40 x 1 1/4"	13094004
32	40 x 1 1/2"	13094005
40	50 x 1 1/2"	13095005
40	50 x 2"	13095006
50	63 x 2"	13096306
65	75 x 2 1/2"	13097507
65	75 x 3"	13097508
80	90 x 3"	13099008
80	90 x 4"	13099009
100	110 x 4"	130911009

ROZMERY A HMOTNOSTI

DN	Vonkajší priemer rúry- \varnothing [mm]	Závit R ISO 7/1	Výrobok č.	A [mm]	B [mm]	D [mm]	Hmotnosť [kg]
10	16	1/2"	13091601	48	39	17	0.020
10	16	3/4"	13091602	49	39	17	0.020
15	20	1/2"	13092001	60	46	21	0.032
15	20	3/4"	13092002	60	46	21	0.036
20	25	1/2"	13092501	72	55	26	0.052
20	25	3/4"	13092502	72	55	26	0.059
20	25	1"	13092503	72	55	26	0.064
25	32	3/4"	13093202	84	64	33	0.092
25	32	1"	13093203	84	64	33	0.093
32	40	1"	13094003	99	74	42	0.149
32	40	1 1/4"	13094004	97	74	42	0.158
32	40	1 1/2"	13094005	99	74	42	0.166
40	50	1 1/2"	13095005	122	87	51	0.241
40	50	2"	13095006	122	87	51	0.294
50	63	2"	13096306	143	107	65	0.415
65	75	2 1/2"	13097507	178	131	78	0.745
65	75	3"	13097508	181	131	78	0.796
80	90	3"	13099008	212	154	92	1.149
80	90	4"	13099009	212	154	92	1.223
100	110	4"	130911009	260	185	112	2.099

KOLENO 90°, S VNÚTORNÝM ZÁVITOM (OD 1 1/4" S UŠLACHTILÁ OCEĽ ZOSILŇOVACÍ KRÚŽOK)



DN	Vonkajší priemer rúry-Ø [mm] x závit	Výrobok č.
10	16 x 1/2"	13131601
10	16 x 3/4"	13131602
15	20 x 1/2"	13132001
15	20 x 3/4"	13132002
20	25 x 1/2"	13132501
20	25 x 3/4"	13132502
20	25 x 1"	13132503
25	32 x 3/4"	13133202
25	32 x 1"	13133203
32	40 x 1"	13134003
32	40 x 1 1/4"	13134004
40	50 x 1 1/2"	13135005
50	63 x 1 1/2"	13136305
50	63 x 2"	13136306
65	75 x 2 1/2"	13137507
65	75 x 3"	13137508
80	90 x 3"	13139008
80	90 x 4"	13139009
100	110 x 4"	131311009

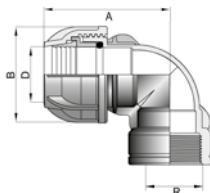

ROZMERY A HMOTNOSTI

DN	Vonkajší priemer rúry-Ø [mm]	Závit R ISO 7/1	Výrobok č.	A [mm]	B [mm]	D [mm]	Hmotnosť [kg]
10	16	1/2"	13131601	49	39	17	0.024
10	16	3/4"	13131602	50	39	17	0.028
15	20	1/2"	13132001	62	46	21	0.033
15	20	3/4"	13132002	60	46	21	0.040
20	25	1/2"	13132501	74	55	26	0.060
20	25	3/4"	13132502	74	55	26	0.065
20	25	1"	13132503	74	55	26	0.069
25	32	3/4"	13133202	87	64	33	0.095
25	32	1"	13133203	87	64	33	0.097
32	40	1"	13134003	96	74	42	0.165
32	40	1 1/4"	13134004	97	74	42	0.176
40	50	1 1/2"	13135005	124	87	51	0.299
50	63	1 1/2"	13136305	144	107	65	0.489
50	63	2"	13136306	145	107	65	0.488
65	75	2 1/2"	13137507	185	131	78	0.809
65	75	3"	13137508	180	131	78	0.843
80	90	3"	13139008	215	154	92	1.242
80	90	4"	13139009	230	154	92	1.283
100	110	4"	131311009	265	185	112	2.168

PRÍRUBOVÝ HRDLOVÝ KUS



DN	Vonkajší priemer rúry- θ [mm] x závit	Prírubové pripojenie, pretlakový stupeň	Počet vŕtaných dier	Výrobok č.
40	50	(DN 50), PN 10/16	4	13625050
50	63	(DN 50), PN 10/16	4	13626350
50	63	(DN 65), PN 10/16	4	13626365
65	75	(DN 65), PN 10/16	4	13627565
65	75	(DN 80), PN 10/16	8	13627580
80	90	(DN 80), PN 10/16	8	13629080
80	90	(DN 100), PN 10/16	8	136290100
100	110	(DN 100), PN 10/16	8	1362110100

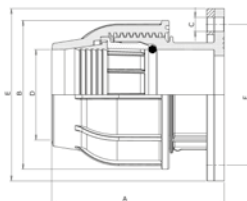

ROZMERY A HMOTNOSTI

DN	Vonkajší priemer rúry- θ [mm]	Prírubové pripojenie, pretlakový stupeň	Výrobok č.	A [mm]	B [mm]	D [mm]	E [mm]	F [mm]	C [mm]	Hmotnosť [kg]
40	50	(DN 50), PN 10/16	13625050	106	87	51	165	125	18	1.446
50	63	(DN 50), PN 10/16	13626350	118	107	65	165	125	18	1.352
50	63	(DN 65), PN 10/16	13626365	123	107	65	185	145	18	2.260
65	75	(DN 65), PN 10/16	13627565	163	131	78	185	145	18	1.995
65	75	(DN 80), PN 10/16	13627580	163	131	78	202	160	18	2.300
80	90	(DN 80), PN 10/16	13629080	189	154	92	202	160	18	2.300
80	90	(DN 100), PN 10/16	136290100	189	154	92	220	180	18	2.035
100	110	(DN 100), PN 10/16	1362110100	224	185	112	220	180	18	3.000

PLASTOVÁ SPOJKA NÁSTENKA S UPEVNENÍM NA STENU



DN	Vonkajší priemer rúry- \emptyset [mm] x závit	Výrobok č.
15	20 x 1/2"	13612001
20	25 x 3/4"	13612502

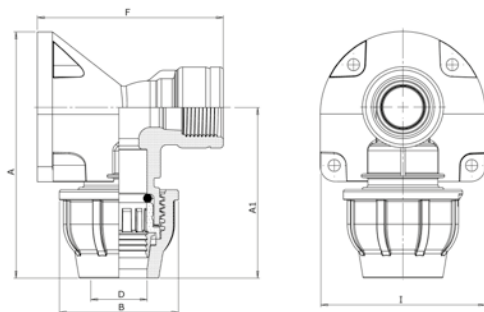

ROZMERY A HMOTNOSTI

DN	Vonkajší priemer rúry- \emptyset [mm]	Závit R ISO 7/1	Výrobok č.	A [mm]	A1 [mm]	B [mm]	D [mm]	F [mm]	I [mm]	Hmotnosť [kg]
15	20	1/2"	13612001	91	67	47	22	63	54	0.060
20	25	3/4"	13612502	113	78	55	26	86	76	0.090

ZÁTKA



DN	Vonkajší priemer rúry- \varnothing [mm]	Výrobok č.
10	16	130716
15	20	130720
20	25	130725
25	32	130732
32	40	130740
40	50	130750
50	63	130763
65	75	130775
80	90	130790
100	110	1307110

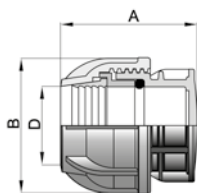

ROZMERY A HMOTNOSTI

DN	Vonkajší priemer rúry- \varnothing [mm]	Výrobok č.	A [mm]	B [mm]	D [mm]	Hmotnosť [kg]
10	16	130716	41	39	17	0.016
15	20	130720	50	46	21	0.027
20	25	130725	58	55	26	0.049
25	32	130732	66	64	33	0.077
32	40	130740	79	74	42	0.124
40	50	130750	98	87	51	0.203
50	63	130763	113	107	65	0.350
65	75	130775	154	131	78	0.568
80	90	130790	179	154	92	0.895
100	110	1307110	210	185	112	1.519

PRÍSLUŠENSTVO



KUŽELOVÁ MATICA

Rozmer [mm]	Výrobok č.	Rozmer [mm]	Výrobok č.
16	134316	50	134350
20	134320	63	134363
25	134325	75	134375
32	134332	90	134390
40	134340	110	1343110



O-KRÚŽOK

Rozmer [mm]	Výrobok č.	Rozmer [mm]	Výrobok č.
16	134716	50	134750
20	134720	63	134763
25	134725	75	134775
32	134732	90	134790
40	134740	110	1347110



PRÍTLAČNÉ TESNENIE

Rozmer [mm]	Výrobok č.	Rozmer [mm]	Výrobok č.
16	137016	50	137050
20	137020	63	137063
25	137025	75	137075
32	137032	90	137090
40	137040	110	1370110



SVORNÝ KRÚŽOK

Rozmer [mm]	Výrobok č.	Rozmer [mm]	Výrobok č.
16	134416	50	134450
20	134420	63	134463
25	134425	75	134475
32	134432	90	134490
40	134440	110	1344110

MONTÁŽNY REMEŇ



Rozmer [mm]	Výrobok č.
25 – 63	13272563
25 – 110	132725110

NÁVOD PRE MONTÁŽ 16 – 63 MM

Montážne kroky:

1. Zrežte rúru v pravom uhle a priložte k sebe (obr. 1).
2. O-krúžok je ošetrený tukom pre ľahšiu montáž. Pre mazanie potrubie nepoužite tuky obsahujúce olej, ale vhodný lubrikant pre pitnú vodu.
3. Uvoľnite kužeľovú maticu 3 – 4 otáčkami skrutky (obr. 2). Nevyskrutkujte kužeľovú maticu úplne !
4. Vyznačte hĺbku zasunutia na rúrke (obr. 3).
5. Zasuňte rúru na doraz do šróbení. Uistite sa, že rúra je vložená za tesniaci element (obr. 4).
6. Kužeľovú maticu dotiahnuť rukou (obr. 5).
7. Pre optimálnu pevnosť utiahnite kužeľovú maticu montážnym remeňom (Alebo iným na plastové nákrutky vhodným nástrojom), (obr. 6).



NÁVOD PRE MONTÁŽ 75 – 110 MM

Montážne kroky:

1. Zrežte rúru v pravom uhle a priložte ju (obr. 1).
2. O-krúžok je ošetrený tukom pre ľahšiu montáž. Pre mazanie potrubie nepoužite tuky obsahujúce olej, ale vhodný lubrikant pre pitnú vodu.
3. Uvoľnite kužeľovú maticu 3 – 4 otáčkami skrutky. Nevyskrutkujte kužeľovú maticu úplne !
4. Uchopte skrutku a ťahajte O-krúžok a svorný krúžok ako najďalej môžete dopredu (obr. 2) tak, aby sa rúra dala bez odporu zasunúť.
5. Zasuňte rúru na doraz do šróbení. Uistite sa, že rúra je vložená za tesniaci element.
6. Kužeľovú maticu dotiahnuť rukou.
7. Pre optimálnu pevnosť utiahnite kužeľovú maticu montážnym remeňom (Alebo iným na plastové nákrutky vhodným nástrojom), (obr. 3).



DÔLEŽITÉ POZNATKY

S pomocou našich navrtávkov je možné namontovať ďalšie odbočky vo vodovodnom rozvode pomocou PE potrubia (potrubí podľa DIN 8074 a DIN EN 12201).

SKÚŠKY

Všetky časti prichádzajúce do styku s pitnou vodou zodpovedajú platným hygienickým požiadavkám.

MATERIÁLY

Vrchný a spodný diel:

Polypropylén kopolymer (PP-B), odolný oproti UV žiareniu

Tesniaci krúžok: NBR/EPDM certifikované pre pitnú vodu

Zosilňovací krúžok:

Ušľachtilá oceľ, AISI 430 - pre vnútorný závit od 1 1/4"

PRETLAKOVÉ STUPNE

Pri teplote do 25 °C je možné použiť navrtávky pre tlaky od PN 16 až do PN 6.

Pretlakové stupne sú závislé na rozmeroch a závitoch, preto je nižšie uvedený pre každý výrobok zodpovedajúci pretlakový stupeň.

NAVRTÁVKA, S DVOMA UPEVŇOVACÍMI SKRUTKAMI



DN	Vonkajší priemer rúry- \emptyset [mm] x závit	Pretlakový stupeň	Výrobok č.
15	20 x 1/2"	PN 16	13212001
20	25 x 1/2"	PN 16	13212501
20	25 x 3/4"	PN 16	13212502
25	32 x 1/2"	PN 16	13213201
25	32 x 3/4"	PN 16	13213202
25	32 x 1"	PN 16	13213203
32	40 x 1/2"	PN 16	13214001
32	40 x 3/4"	PN 16	13214002
32	40 x 1"	PN 16	13214003
40	50 x 1/2"	PN 16	13215001
40	50 x 3/4"	PN 16	13215002
40	50 x 1"	PN 16	13215003

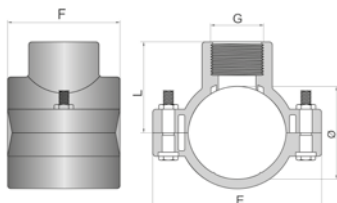

ROZMERY A HMOTNOSTI

DN	Vonkajší priemer rúry- \emptyset [mm]	Závitové pripojenie G	Výrobok č.	L [mm]	E [mm]	F [mm]	Skrutky	Hmotnosť [kg]
15	20	1/2"	13212001	33	62	38	M6 x 35	0.047
20	25	1/2"	13212501	33	72	48	M6 x 35	0.060
20	25	3/4"	13212502	34	72	48	M8 x 45	0.070
25	32	1/2"	13213201	39	87	52	M8 x 45	0.110
25	32	3/4"	13213202	40	87	52	M8 x 45	0.113
25	32	1"	13213203	47	88	56	M8 x 45	0.137
32	40	1/2"	13214001	42	88	56	M8 x 45	0.117
32	40	3/4"	13214002	42	88	56	M8 x 45	0.118
32	40	1"	13214003	47	88	56	M8 x 45	0.128
40	50	1/2"	13215001	46	95	57	M8 x 45	0.119
40	50	3/4"	13215002	48	95	57	M8 x 45	0.124
40	50	1"	13215003	51	95	57	M8 x 45	0.132

NAVRTÁVKA, SO ŠTYRMI UPEVŇOVAČÍMI SKRUTKAMI

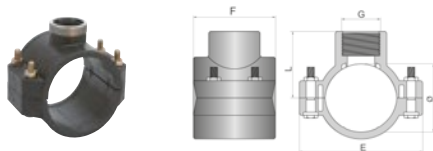

DN	Vonkajší priemer rúry-Ø [mm] x závit	Pretlakový stupeň	Výrobok č.
50	63 x 1/2"	PN 16	13236301
50	63 x 3/4"	PN 16	13236302
50	63 x 1"	PN 16	13236303
50	63 x 1 1/4"	PN 16	13236304
50	63 x 1 1/2"	PN 10	13236305
65	75 x 1/2"	PN 16	13237501
65	75 x 3/4"	PN 16	13237502
65	75 x 1"	PN 16	13237503
65	75 x 1 1/4"	PN 16	13237504
65	75 x 1 1/2"	PN 10	13237505
65	75 x 2"	PN 10	13237506
80	90 x 1/2"	PN 16	13239001
80	90 x 3/4"	PN 16	13239002
80	90 x 1"	PN 16	13239003
80	90 x 1 1/4"	PN 16	13239004
80	90 x 1 1/2"	PN 10	13239005
80	90 x 2"	PN 10	13239006
100	110 x 1/2"	PN 16	132311001
100	110 x 3/4"	PN 16	132311002
100	110 x 1"	PN 16	132311003
100	110 x 1 1/4"	PN 16	132311004
100	110 x 1 1/2"	PN 10	132311005
100	110 x 2"	PN 10	132311006
100	110 x 2 1/2"	PN 6	132311007
100	110 x 3"	PN 6	132311008

ROZMERY A HMOTNOSTI

DN	Vonkajší priemer rúry-Ø [mm]	Závitové pripojenie G	Výrobok č.	L [mm]	E [mm]	F [mm]	Skrutky	Hmotnosť [kg]
50	63	1/2"	13236301	53	108	72	M8 x 45	0.210
50	63	3/4"	13236302	55	108	72	M8 x 45	0.210
50	63	1"	13236303	58	108	72	M8 x 45	0.220
50	63	1 1/4"	13236304	60	108	72	M8 x 45	0.231
50	63	1 1/2"	13236305	60	108	72	M8 x 45	0.223
65	75	1/2"	13237501	60	120	90	M8 x 60	0.330
65	75	3/4"	13237502	61	120	90	M8 x 60	0.340
65	75	1"	13237503	65	120	90	M8 x 60	0.350
65	75	1 1/4"	13237504	67	120	90	M8 x 60	0.361
65	75	1 1/2"	13237505	67	120	90	M8 x 60	0.370
65	75	2"	13237506	70	120	90	M8 x 60	0.390
80	90	1/2"	13239001	68	135	90	M8 x 60	0.360
80	90	3/4"	13239002	69	135	90	M8 x 60	0.360
80	90	1"	13239003	73	135	90	M8 x 60	0.370
80	90	1 1/4"	13239004	75	135	90	M8 x 60	0.380
80	90	1 1/2"	13239005	75	135	90	M8 x 60	0.390
80	90	2"	13239006	78	135	90	M8 x 60	0.410
100	110	1/2"	132311001	78	155	105	M8 x 60	0.450
100	110	3/4"	132311002	79	155	105	M8 x 60	0.460
100	110	1"	132311003	83	155	105	M8 x 60	0.460
100	110	1 1/4"	132311004	85	155	105	M8 x 60	0.460
100	110	1 1/2"	132311005	85	155	105	M8 x 60	0.470
100	110	2"	132311006	88	155	105	M8 x 60	0.500
100	110	2 1/2"	132311007	94	155	105	M8 x 60	0.523
100	110	3"	132311008	103	155	124	M8 x 70	0.671

NÁVOD PRE MONTÁŽ

Montážne postupy:

1. Zvoľte miesto vývodu a uistite sa, že rúra je bez nečistôt, povrchového poškodenia alebo poškrabania.
2. Umiestnite spodnú stranu navrtávky.
3. Umiestnite tesnenie na stanovené miesto a namontujte horné časti navrtávky. Pripojte ich k dolnej časti.
4. Uistite sa, že obe časti sedla sú pripevnené k bloku.
5. Vložte skrutky zdola a dobre utiahnite matky.
6. Navrťajte rúru, ale bez poškodenia závitov a tesnenia.

Použite dištančný držiak, aby sa rúra nenavrtala na opačnej strane.

Odporúčame Vám, aby ste pre vŕtanie použili dierové píly, aby sa zabránilo poškodeniu tesnenia a závitov.



1



2



3

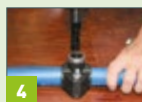

4

DODATOČNÉ MONTÁŽNE ZARIADENIA K PLASTOVÝM SPOJKÁM

Oprava spojok pre PE rúrky ako doplnok k sortimentu Gebo Plast



DN	Vonkajší priemer rúry- \varnothing [mm]	Výrobok č.
15	20 x 20	15020K0020
20	25 x 25	15025K0025
25	32 x 32	15032K0032
32	40 x 40	15040K0040
40	50 x 50	15050K0050
50	63 x 63	15063K0063
65	75 x 75	15075K0075
80	90 x 90	15090K0090
100	110 x 110	15110K0110